

1 tap hole
1 drain hole

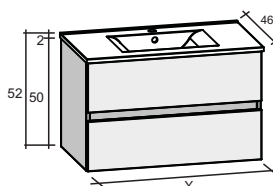

Y = 600-800-1000mm

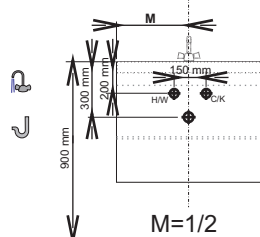

2 tap holes
2 drain holes

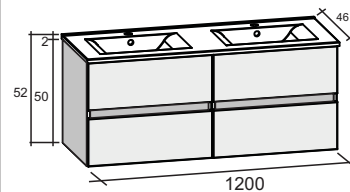

Y = 1200mm

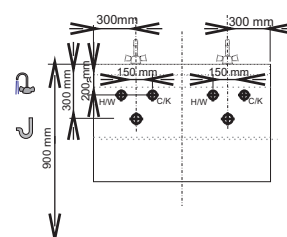

Remove drawer

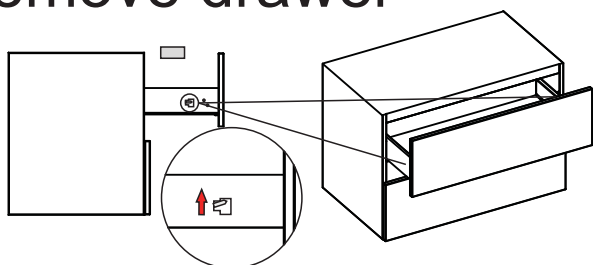

Remove front

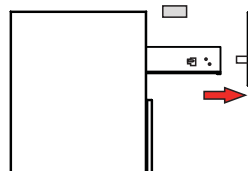
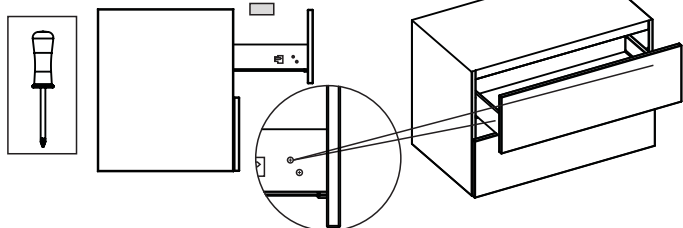

Adjust height

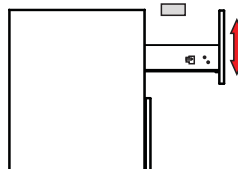
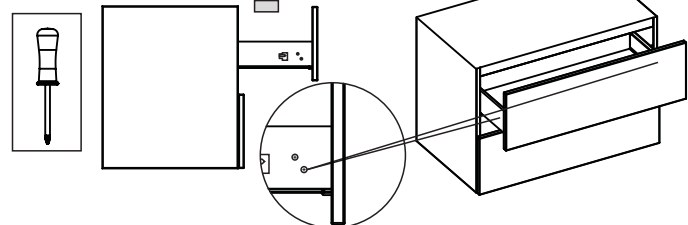

Adjust left-right

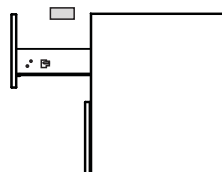
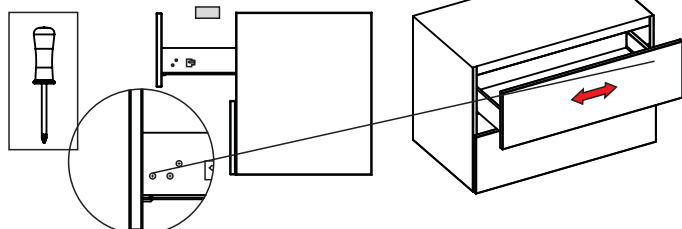

Wall mount:

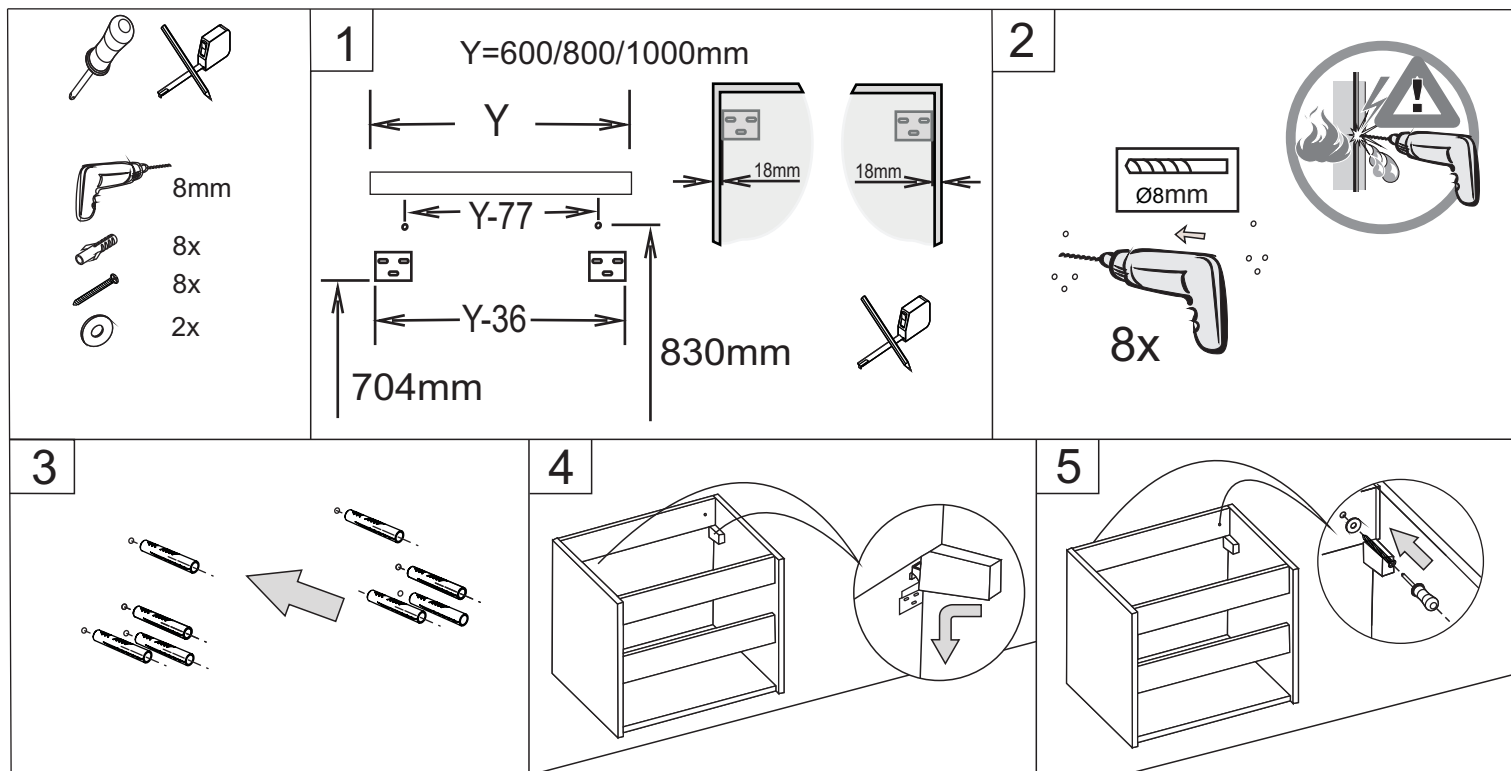

Built - in led driver

